

CABLE KNIT SCARF

Artwork Layout

NOTE: ART SHOWN AT 10%
Scarf Dimensions: 54.5" W X 6.75" H
Fringe Dimensions: 3.5"



DESIGN INFORMATION

Only solid and stripes are available
All scarves require care tag

CABLE KNIT SCARF

WOVEN CUFF TAG

Artwork Layout

NOTE: ART SHOWN AT 100%

Artwork should be within blue lines

Orange dotted line marks fold line

WOVEN CUFF TAG (up to 3sq in)

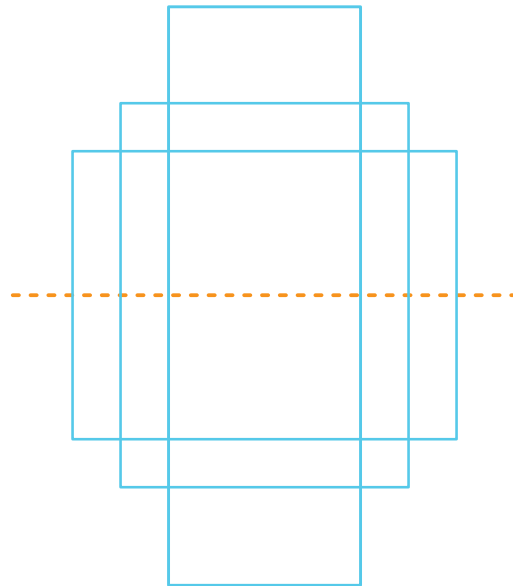

DESIGN INFORMATION

- Can be included in base pricing
- Allow 5mm seam allowance on top & bottom edge
- Tag must fold in center
- Woven Tag can be up to 7 colors

PLEASE NOTE: ALL ARTWORK NEEDS TO BE EVALUATED FOR MANUFACTURABILITY

CABLE KNIT SCARF

EMBROIDERY

Artwork Layout

NOTE: Art shown at 100% of actual size
Artwork should be within blue lines

SMALL (up to 2.5sq in)

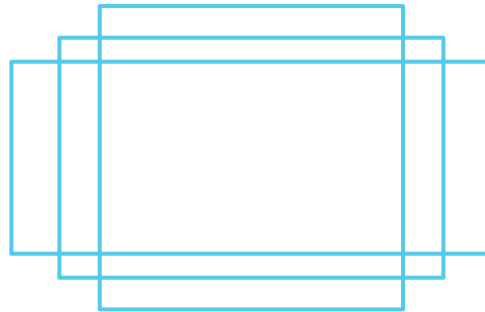

MEDIUM (up to 4sq in)



LARGE (up to 6sq in)

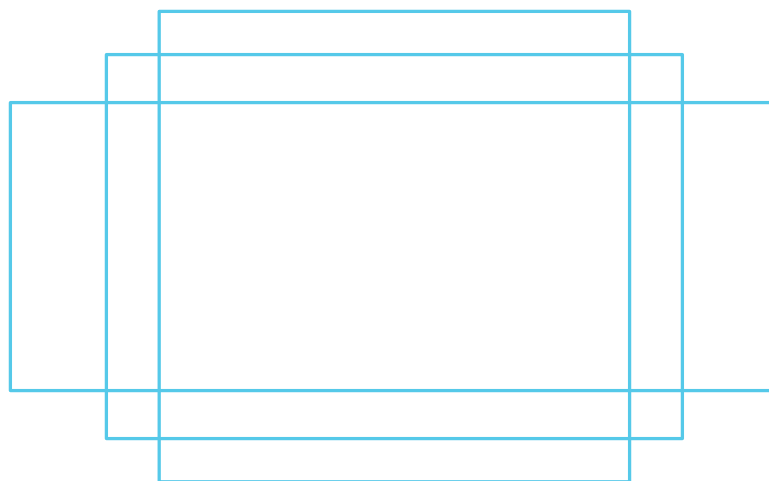

DESIGN INFORMATION

Direct and Layer embroidery can be up to 6 colors
Full Coverage Embroidery can be up to 8 colors
Embroidery cannot be wider than 13cm

PLEASE NOTE: ALL ARTWORK NEEDS TO BE EVALUATED FOR MANUFACTURABILITY

CABLE KNIT SCARF

WOVEN PATCH

Artwork Layout

NOTE: Art shown at 100% of actual size
Artwork should be within blue lines

STANDARD (up to 7sq in)



LARGE (up to 14 sq in)



DESIGN INFORMATION

Woven Patches can be up to 5 colors
Patches cannot be wider than 13cm

PLEASE NOTE: ALL ARTWORK NEEDS TO BE EVALUATED FOR MANUFACTURABILITY

CABLE KNIT SCARF

FULL COLOR PATCH

Artwork Layout

NOTE: Art shown at 100% of actual size
Artwork should be within blue lines

SMALL (up to 2"x2")



MEDIUM (up to 3.15" x 3.15")

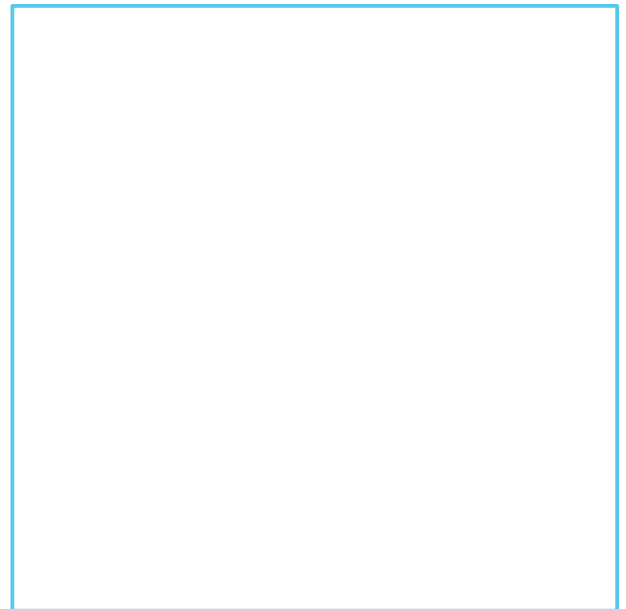

LARGE (up to 4"x4")

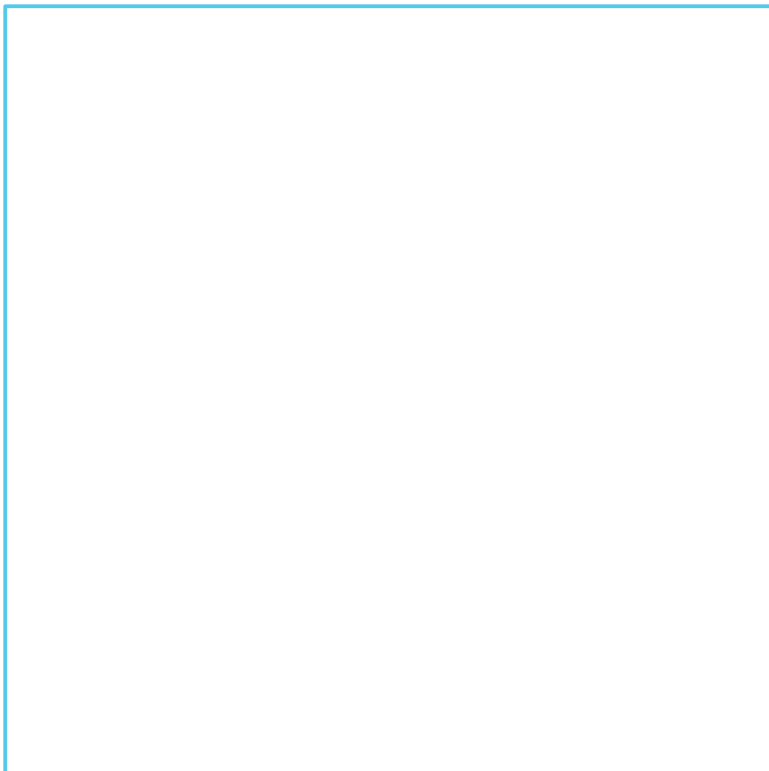

DESIGN INFORMATION

Full Color Patches are CMYK Printed
Patches cannot be wider than 13cm

PLEASE NOTE: ALL ARTWORK NEEDS TO BE EVALUATED FOR MANUFACTURABILITY

CABLE KNIT SCARF

VEGAN LEATHER PATCH

Artwork Layout

NOTE: Art shown at 100% of actual size
Artwork should be within blue lines

STANDARD (up to 7sq in)



Dark Gray
PMS 7540 C

LOGO

Orange Brown
PMS 7566 C

LOGO

Dark Brown
PMS 7582 C

DESIGN INFORMATION

Vegan leather patches are closest match to 3 colors only

PLEASE NOTE: ALL ARTWORK NEEDS TO BE EVALUATED FOR MANUFACTURABILITY

CABLE KNIT SCARF

WOVEN CUFF TAG

Artwork Layout

NOTE: Art shown at 100% of actual size

----- Hole punch margin area
Black line marks product edge

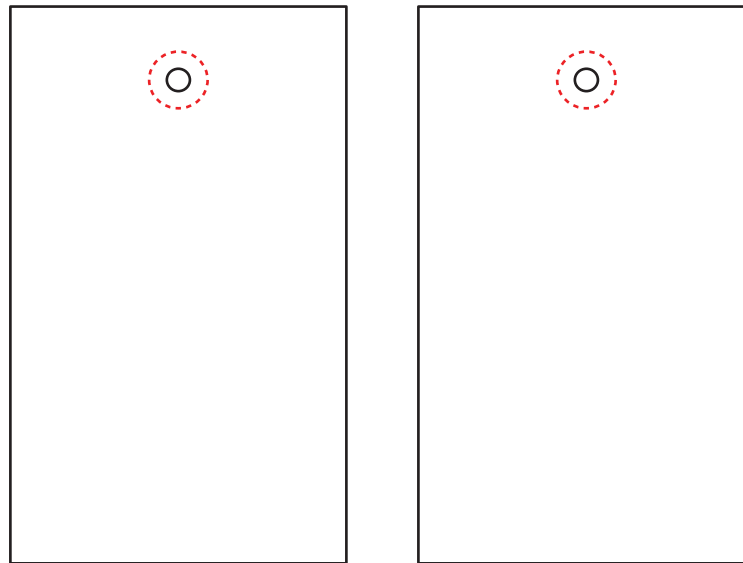

FRONT

BACK

Hang Tag Placement

Front of Winter Scarf In Fringe Seam

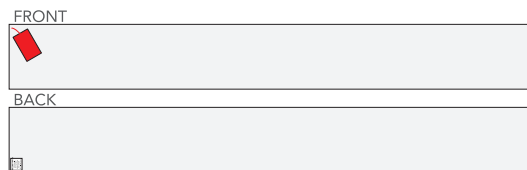

ARTWORK FOR PLACEMENT REFERENCE ONLY

DESIGN INFORMATION

This is CMYK printed, all PMS colors are for reference only